



CITY

7236



4265053

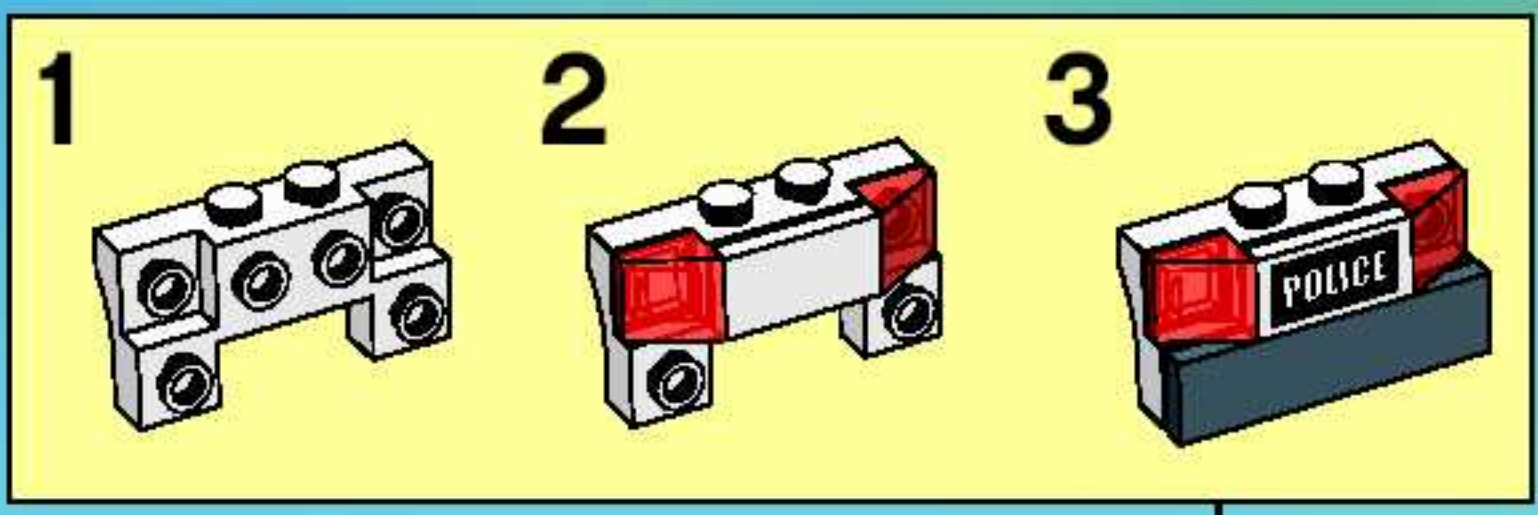

2

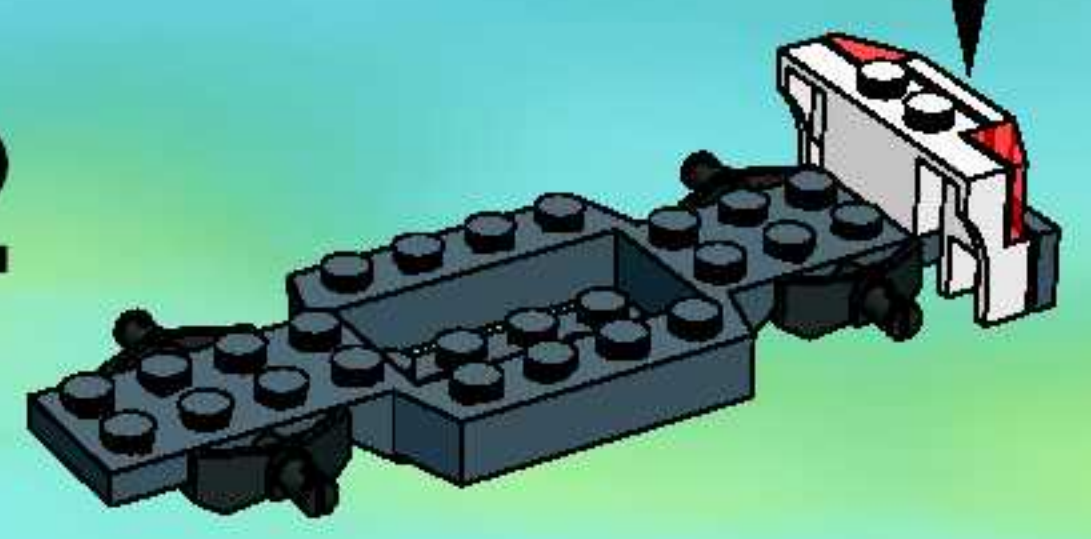

3

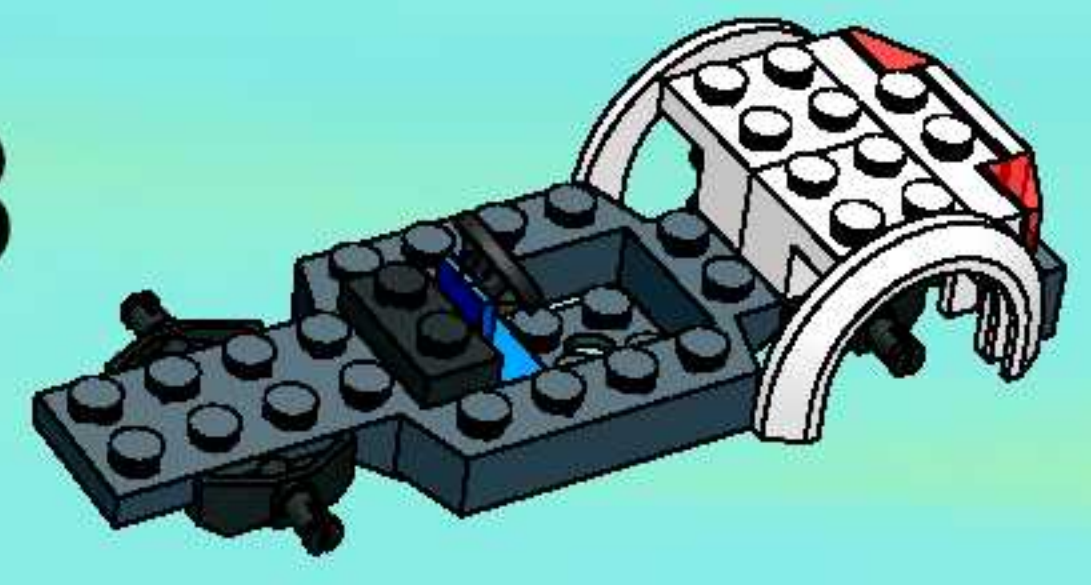

4

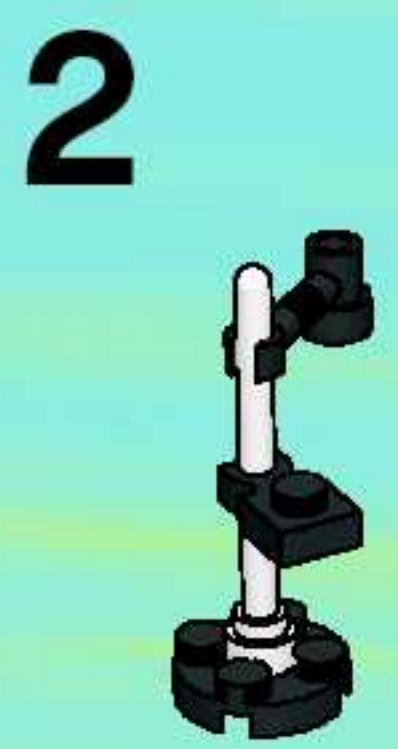
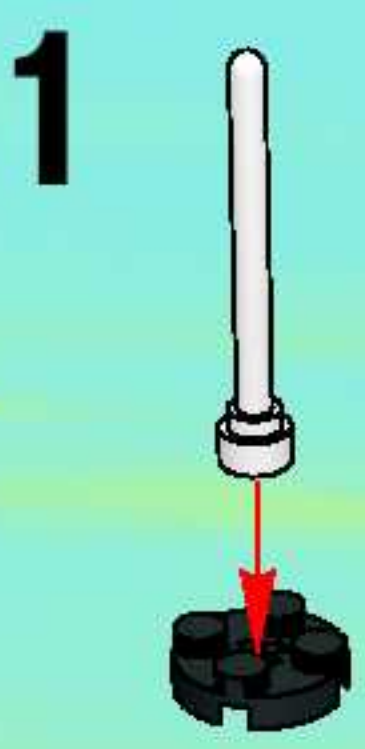
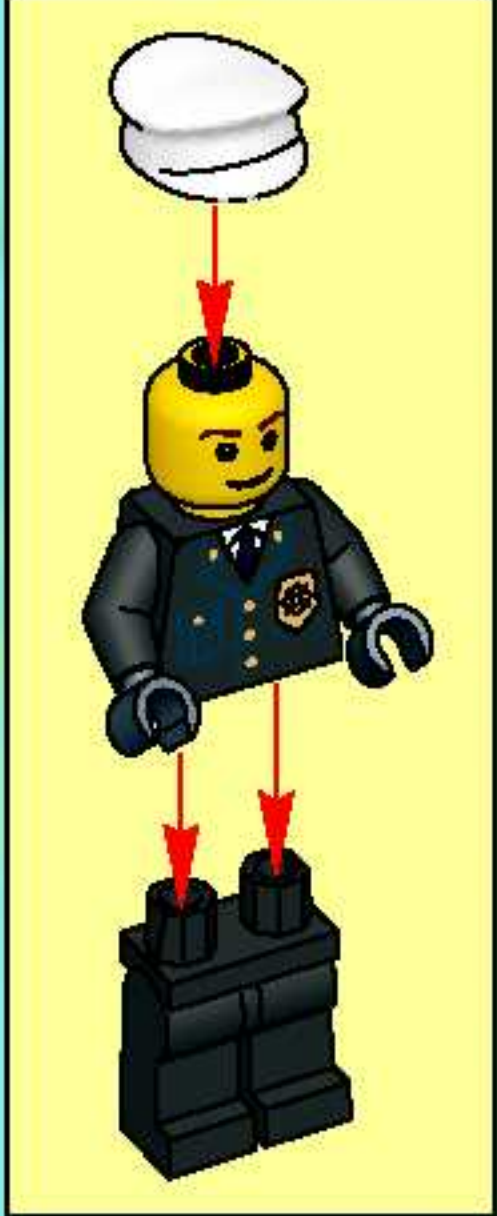
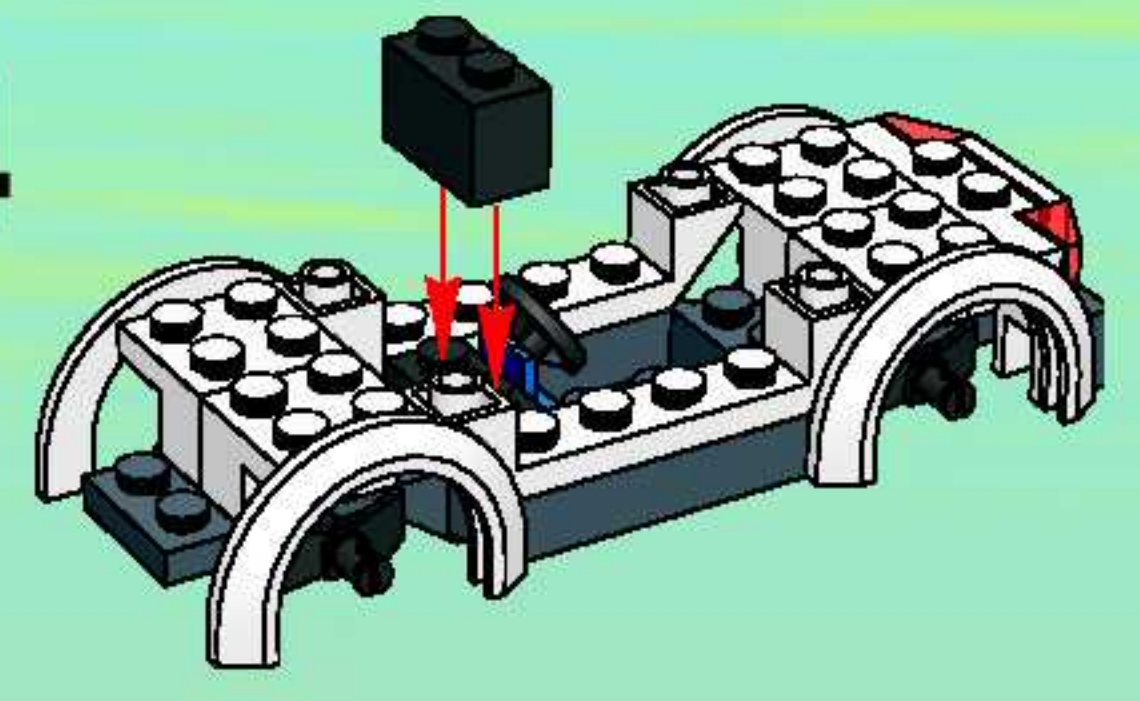

1

